

THE LETTER A

Trace the letter A:

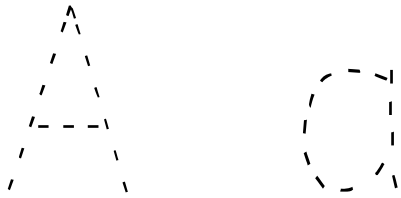

Write an upper and lower case letter A:

Colour all the items that begin with the letter A:

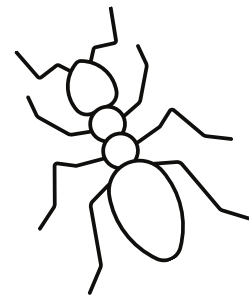
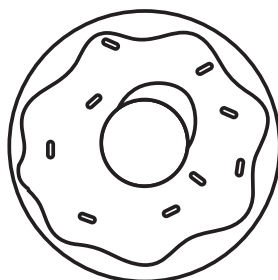
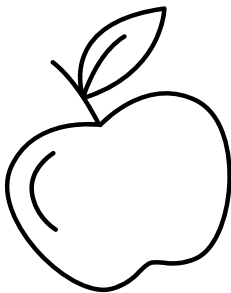
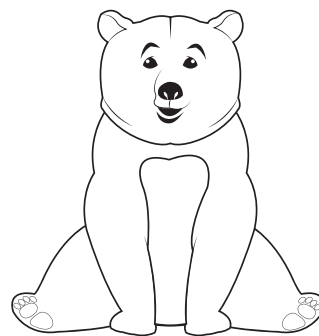
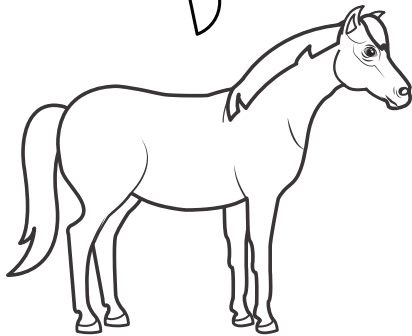
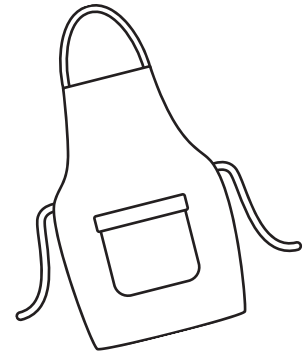
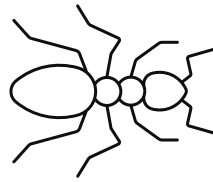
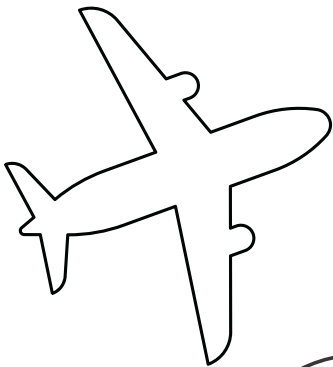

THE LETTER B

Trace the letter B:

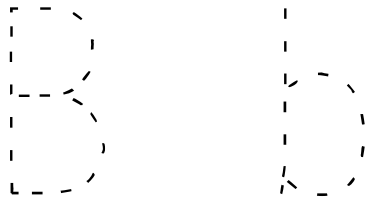

Write an upper and lower case letter B:

Colour all the items that begin with the letter B:

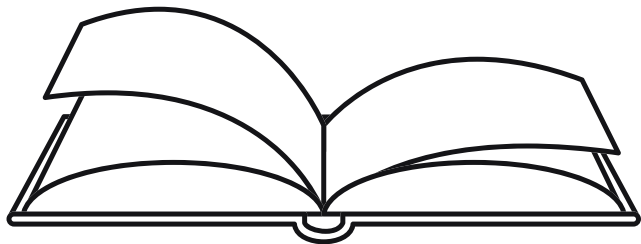
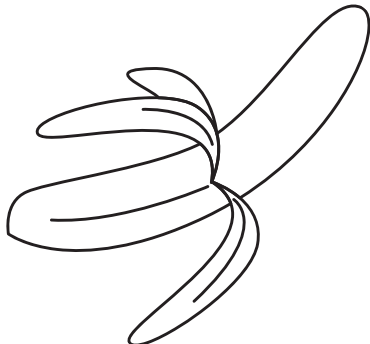
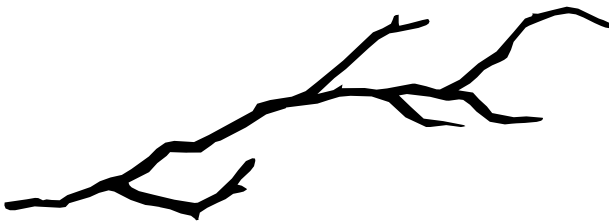
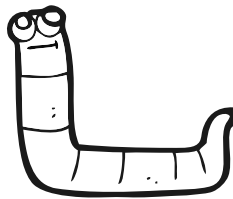
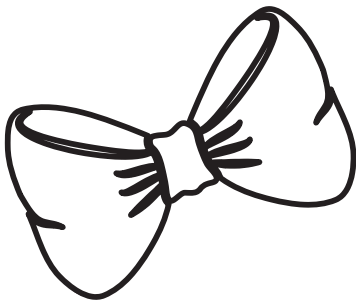

THE LETTER C

Trace the letter C:

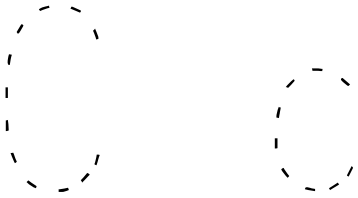

Write an upper and lower case letter C:

Colour all the items that begin with the letter C:

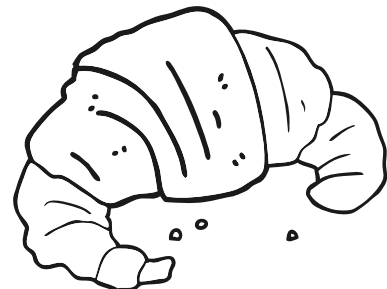
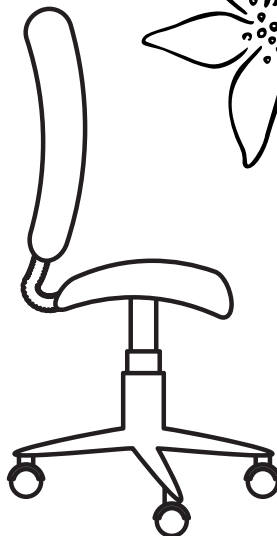
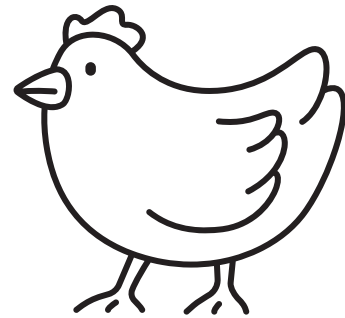
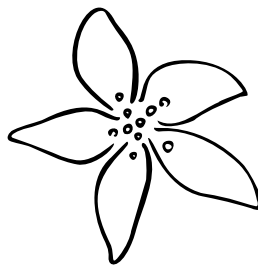
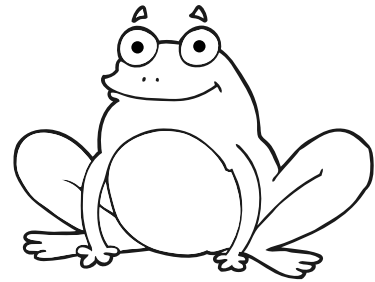
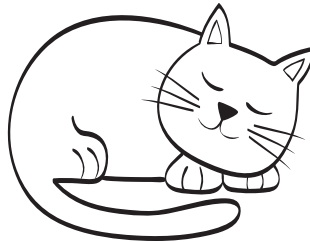
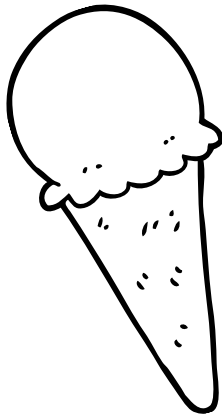

THE LETTER D

Trace the letter D:

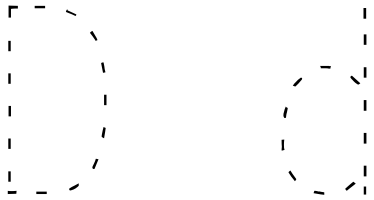

Write an upper and lower case letter D:

Colour all the items that begin with the letter D:

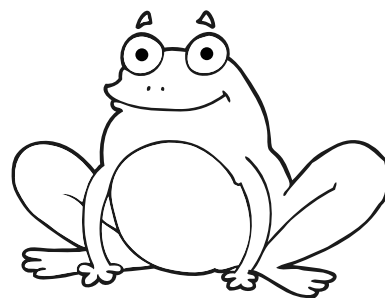
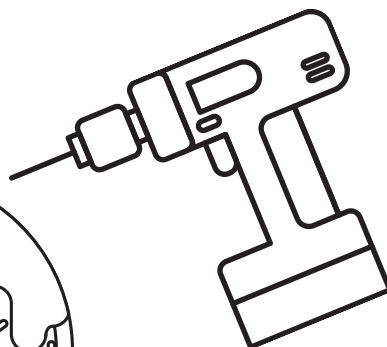
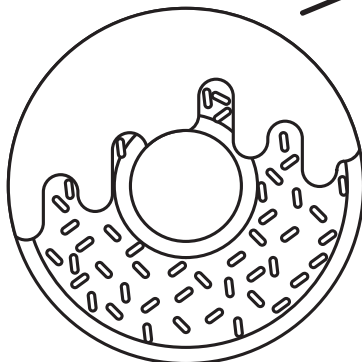
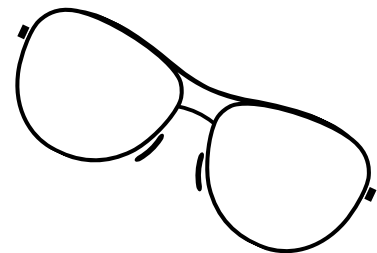
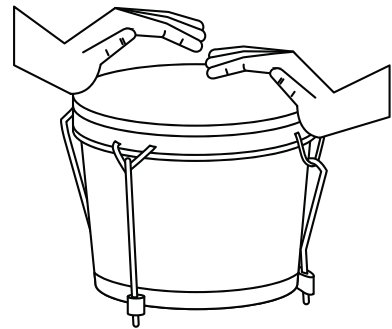
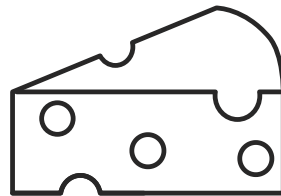
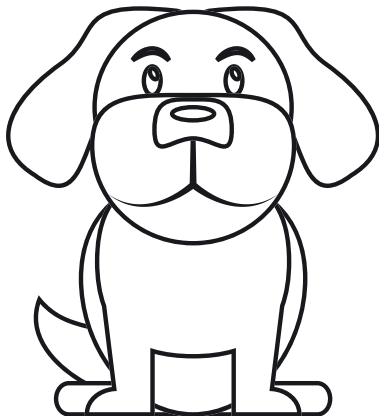

THE LETTER E

Trace the letter E:

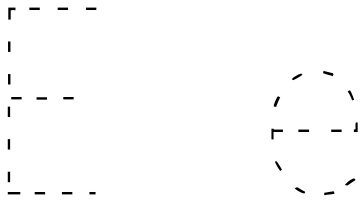

Write an upper and lower case letter E:

Colour all the items that begin with the letter E:

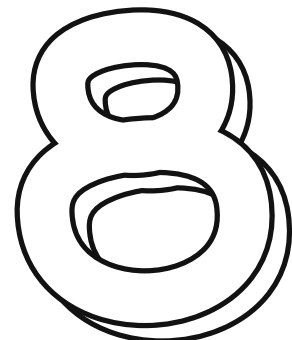
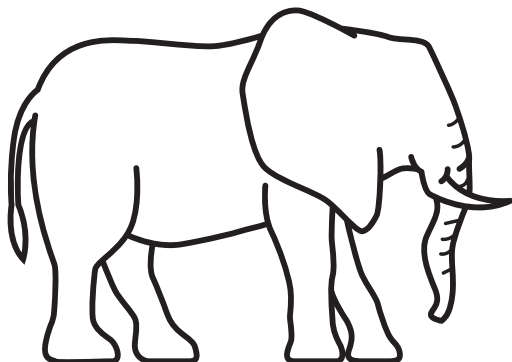
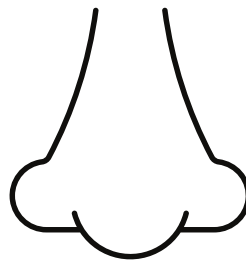
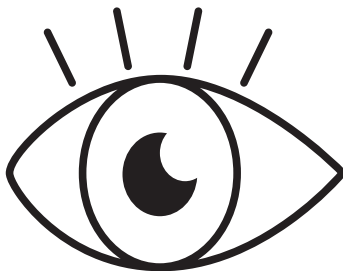
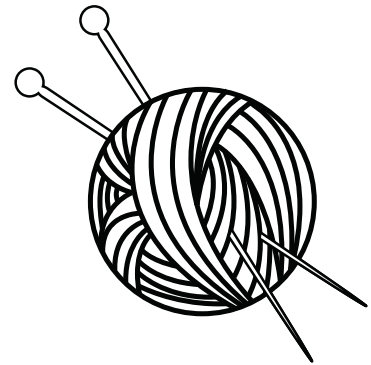
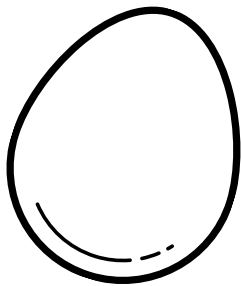

THE LETTER F

Trace the letter F:

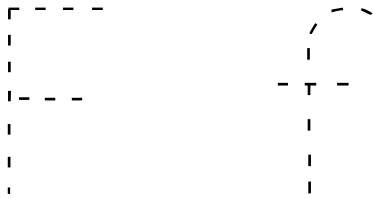

Write an upper and lower case letter F:

Colour all the items that begin with the letter F:

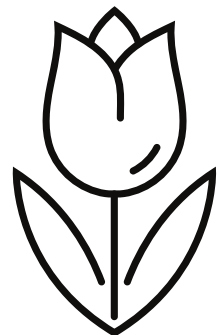
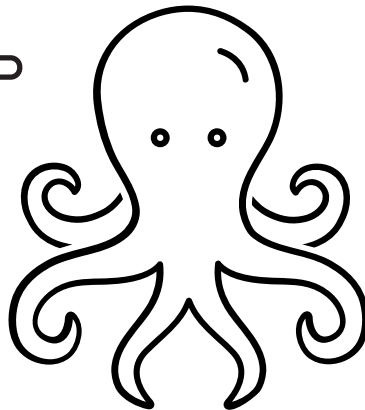
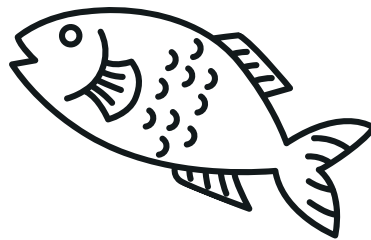
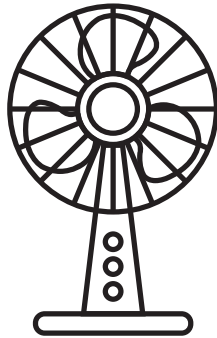
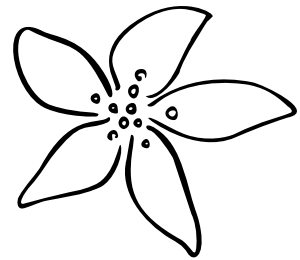
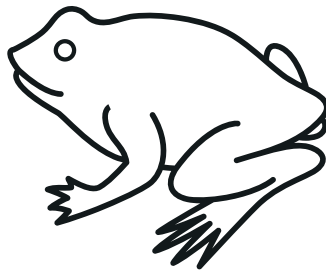

THE LETTER G

Trace the letter G:

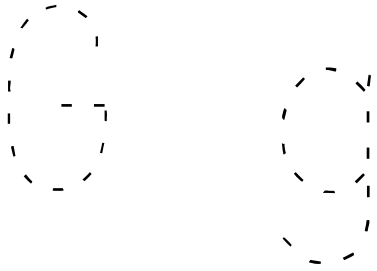

Write an upper and lower case letter G:

Colour all the items that begin with the letter G:

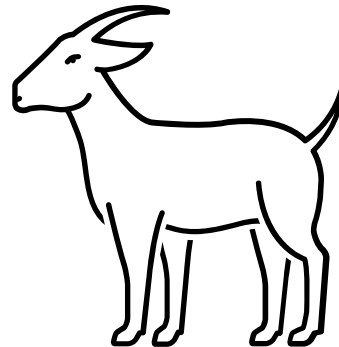
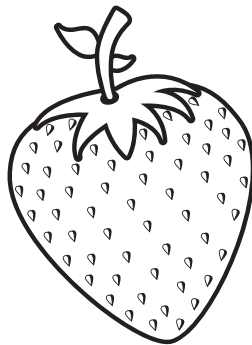
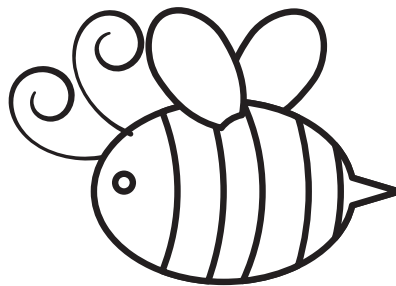
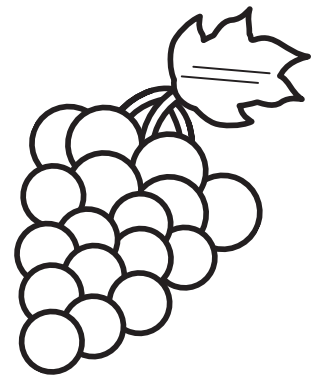
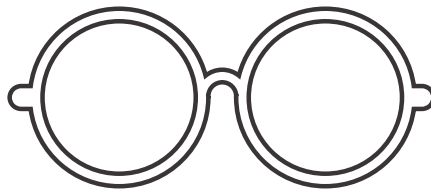
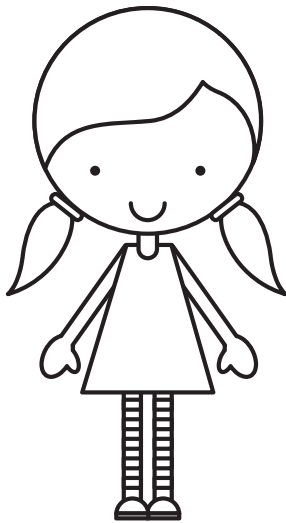

THE LETTER H

Trace the letter H:

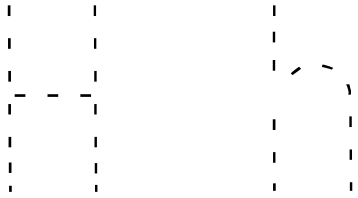

Write an upper and lower case letter H:

Colour all the items that begin with the letter H:

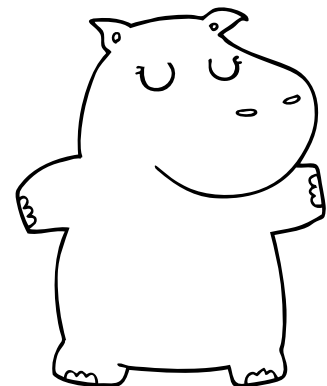
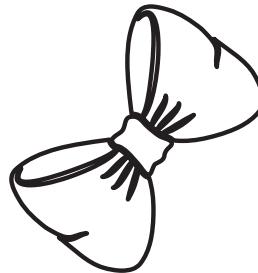
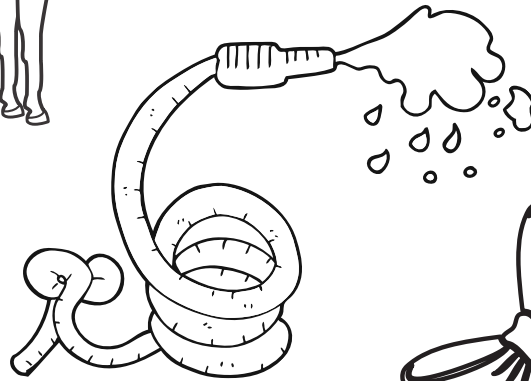
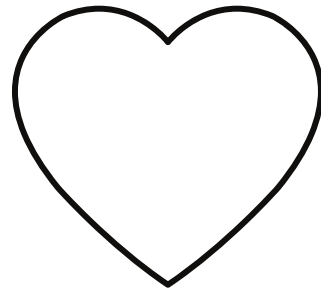
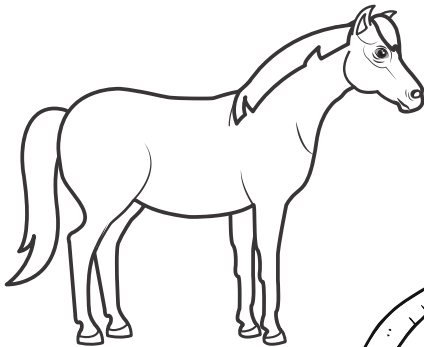

THE LETTER I

Trace the letter I:



Write an upper and lower case letter I:

Colour all the items that begin with the letter I:

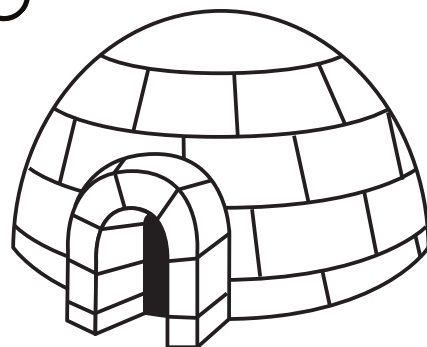
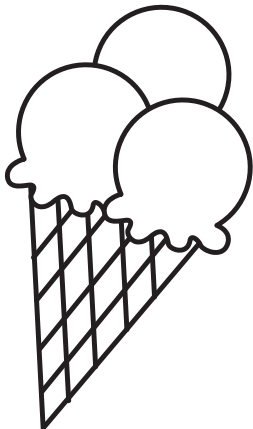
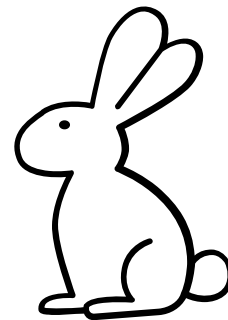
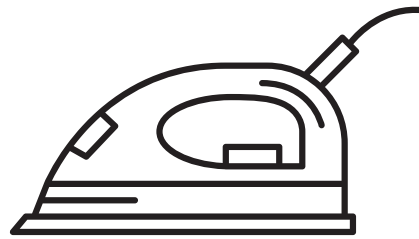
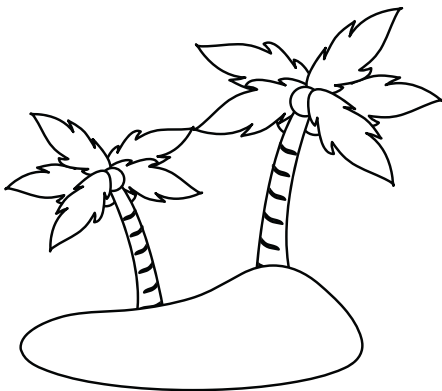

THE LETTER J

Trace the letter J:



Write an upper and lower case letter J:

Colour all the items that begin with the letter J:

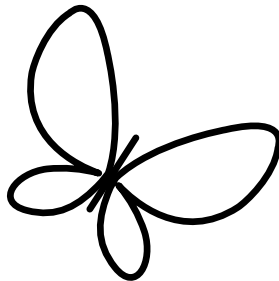
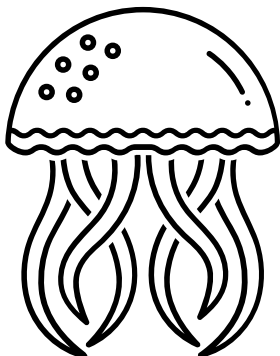
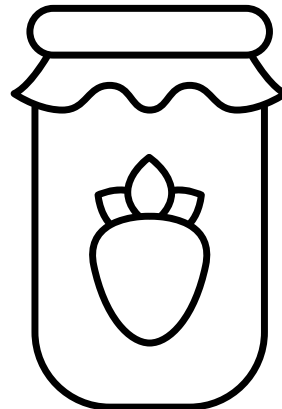
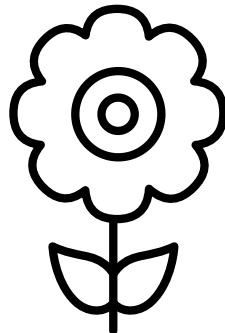
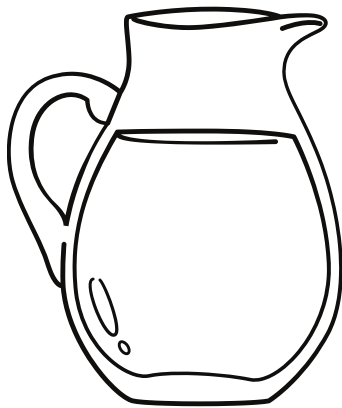

THE LETTER K

Trace the letter K:

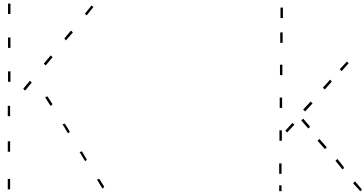

Write an upper and lower case letter K:

Colour all the items that begin with the letter K:

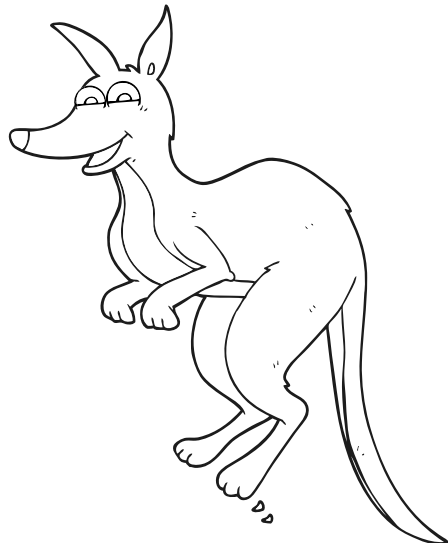
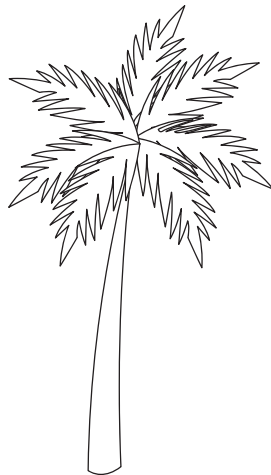
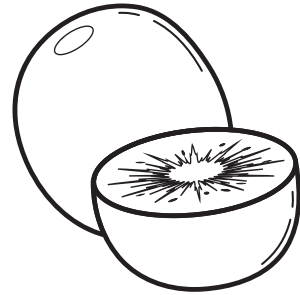
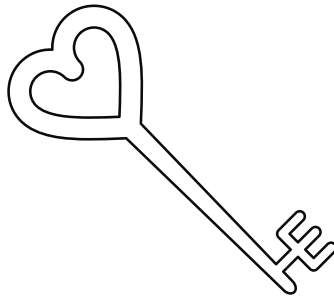
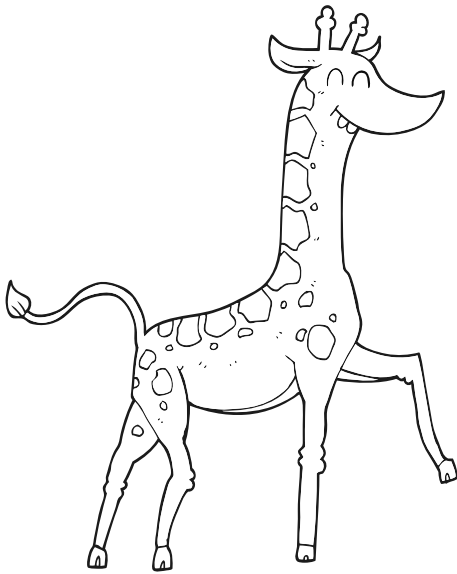

THE LETTER L

Trace the letter L:



Write an upper and lower case letter L:

Colour all the items that begin with the letter L:

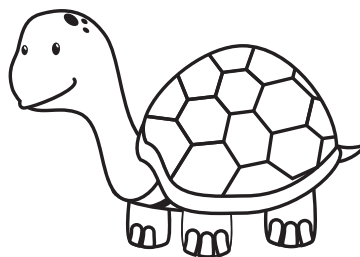
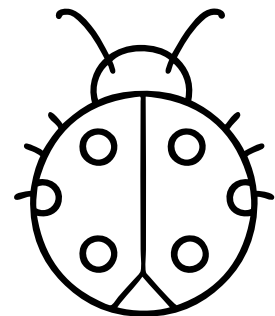
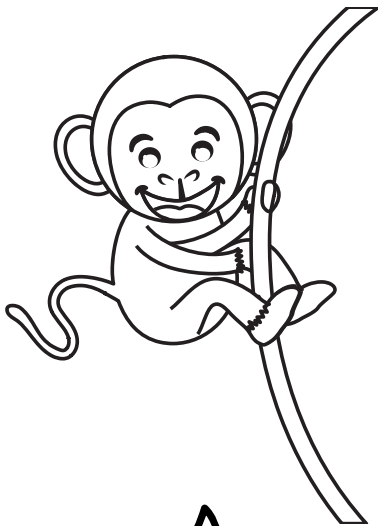
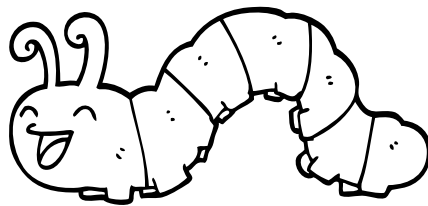

THE LETTER M

Trace the letter M:

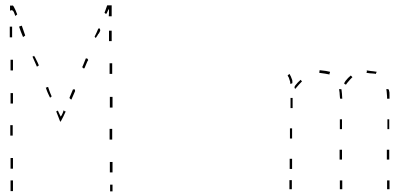

Write an upper and lower case letter M:

Colour all the items that begin with the letter M:

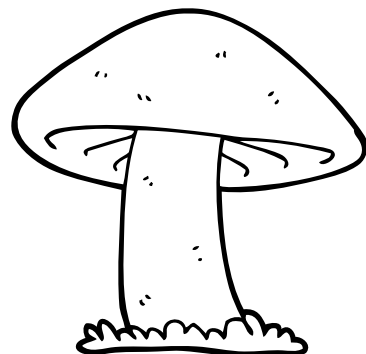
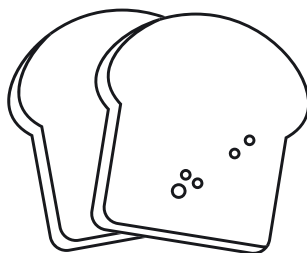
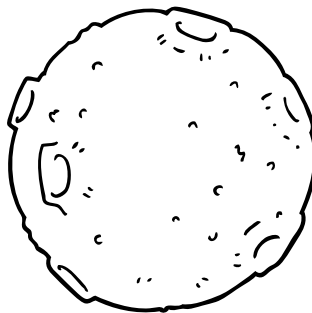
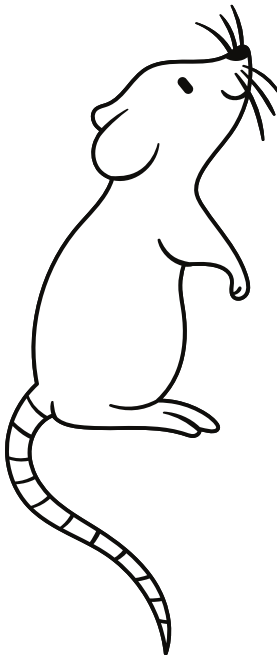
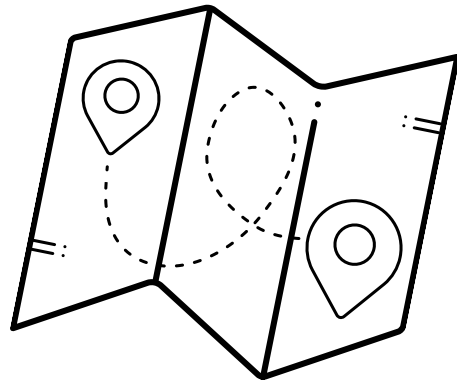
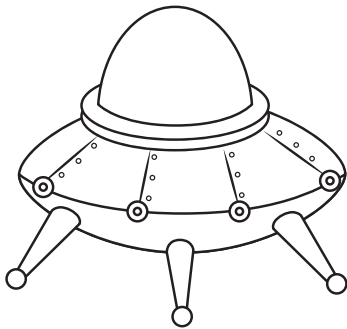

THE LETTER N

Trace the letter N:

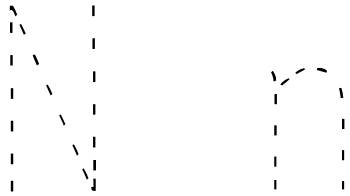

Write an upper and lower case letter N:

Colour all the items that begin with the letter N:

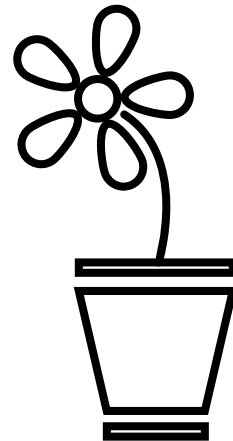
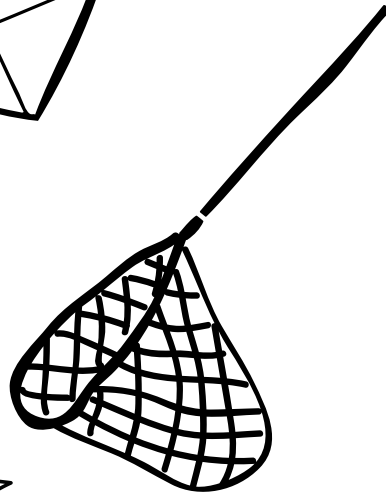
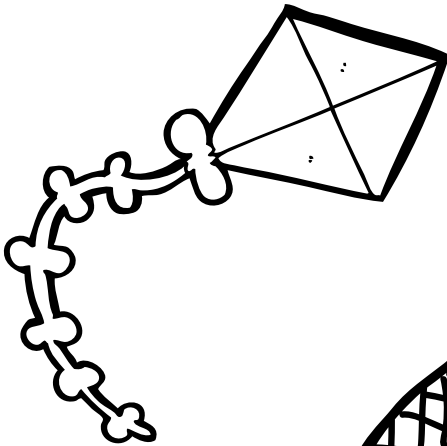
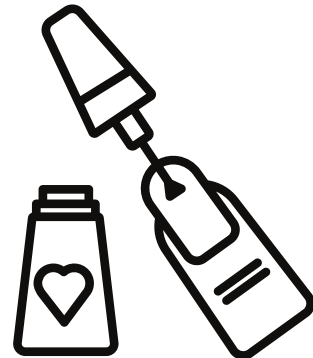

THE LETTER O

Trace the letter O:

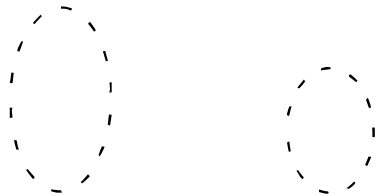

Write an upper and lower case letter O:

Colour all the items that begin with the letter O:

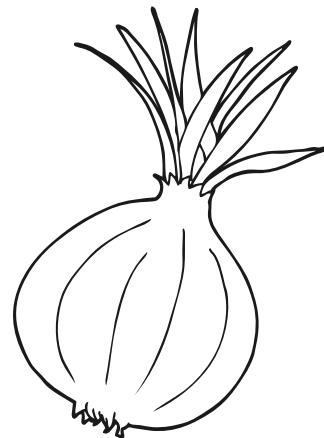
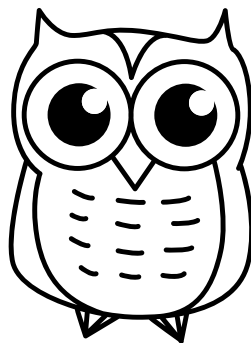
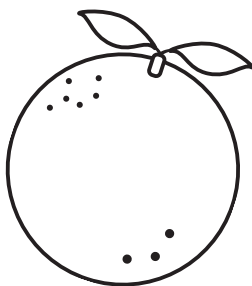
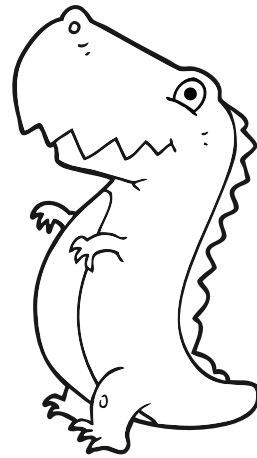
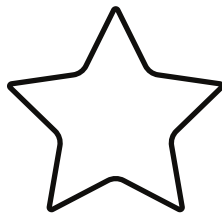

THE LETTER P

Trace the letter P:

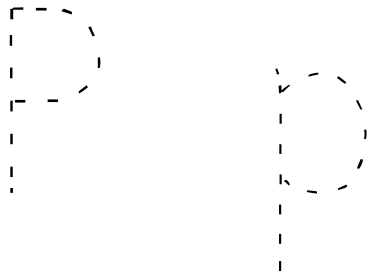

Write an upper and lower case letter P:

Colour all the items that begin with the letter P:

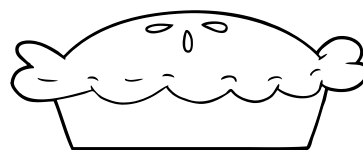
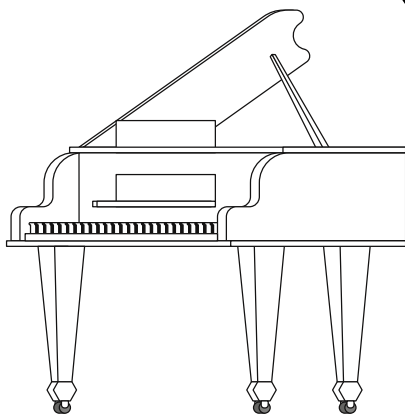
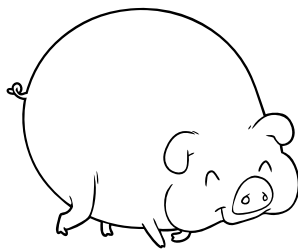
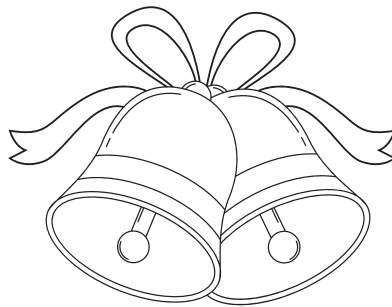

THE LETTER Q

Trace the letter Q:

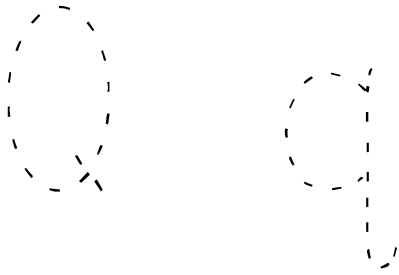

Write an upper and lower case letter Q:

Colour all the items that begin with the letter Q:

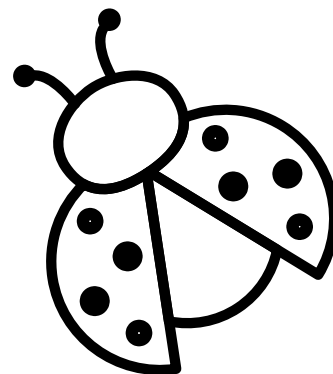
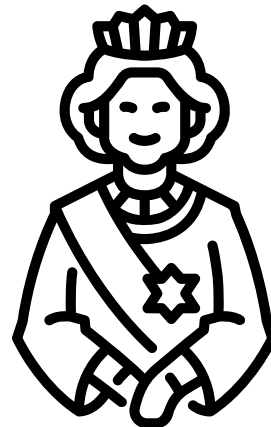
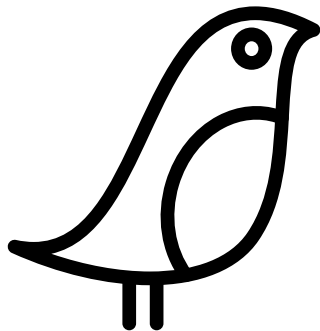

THE LETTER R

Trace the letter R:

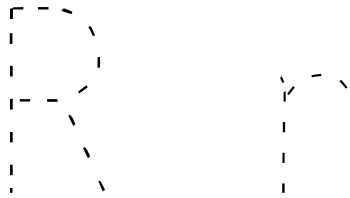

Write an upper and lower case letter R:

Colour all the items that begin with the letter R:

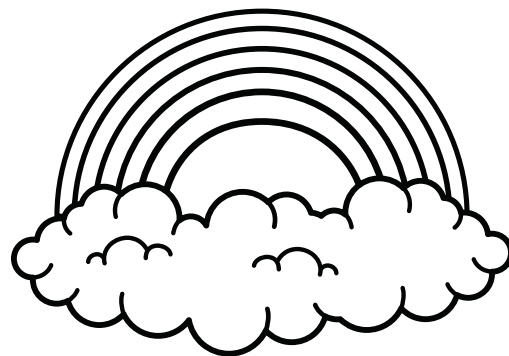
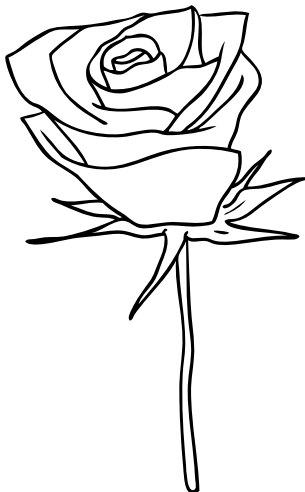
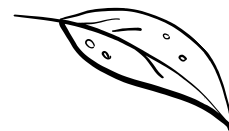
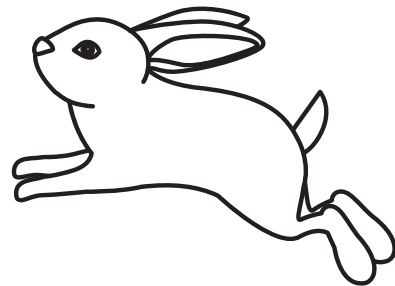

THE LETTER S

Trace the letter S:



Write an upper and lower case letter S:

Colour all the items that begin with the letter S:

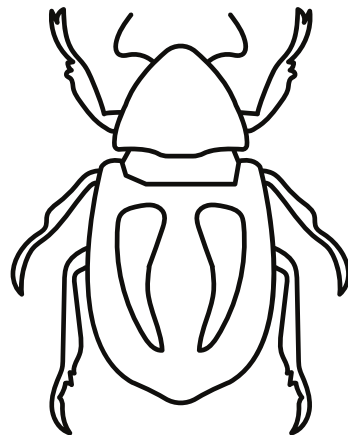
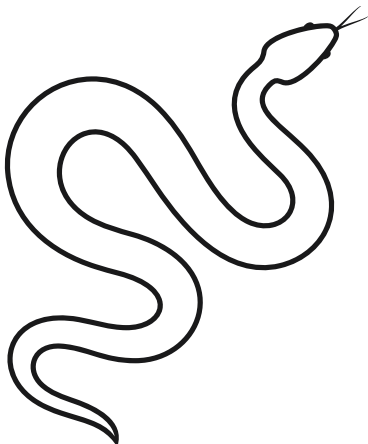
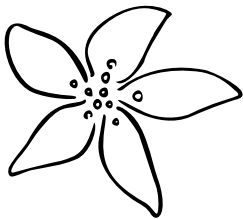
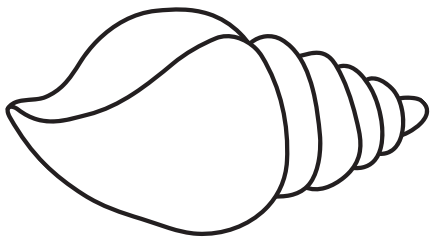

THE LETTER T

Trace the letter T:

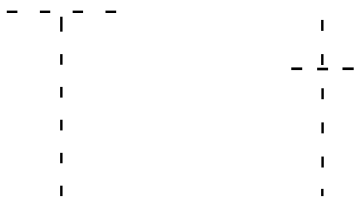

Write an upper and lower case letter T:

Colour all the items that begin with the letter T:



THE LETTER U

Trace the letter U:

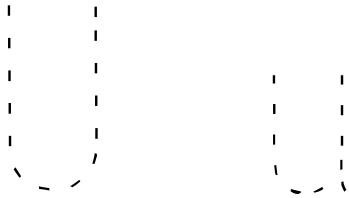

Write an upper and lower case letter U:

Colour all the items that begin with the letter U:

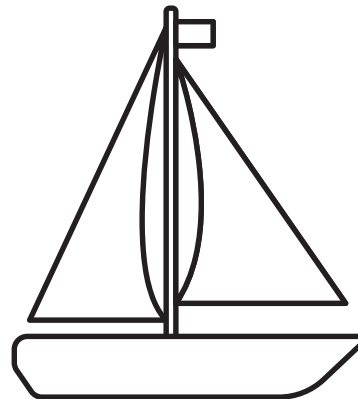
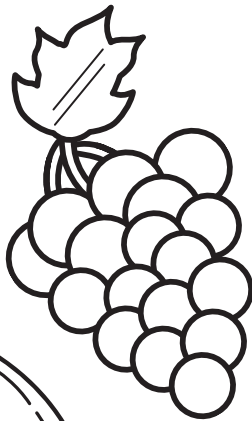
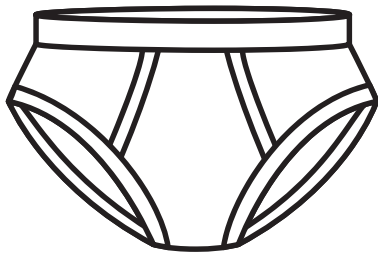

THE LETTER U

Trace the letter U:

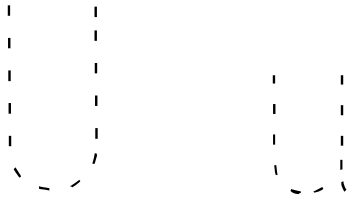

Write an upper and lower case letter U:

Colour all the items that begin with the letter U:

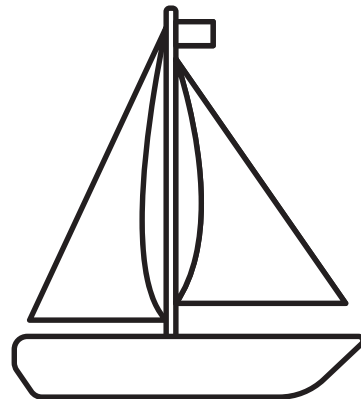
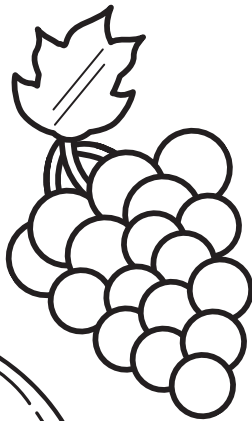
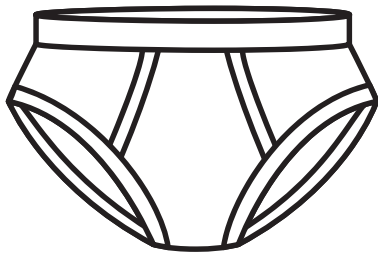

THE LETTER V

Trace the letter V:

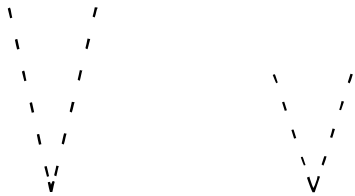

Write an upper and lower case letter V:

Colour all the items that begin with the letter V:

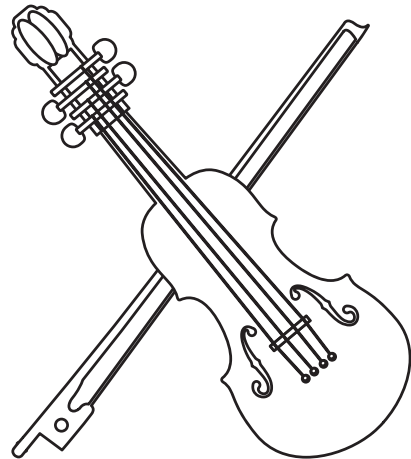
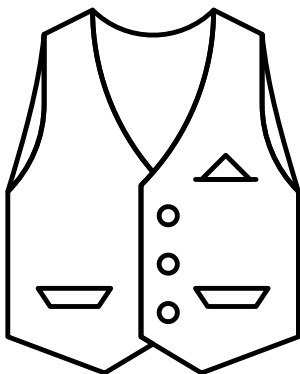
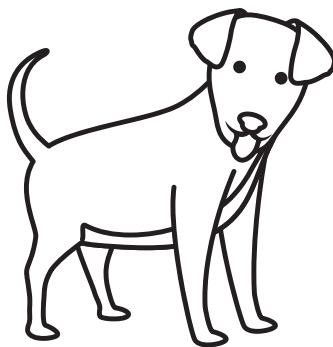
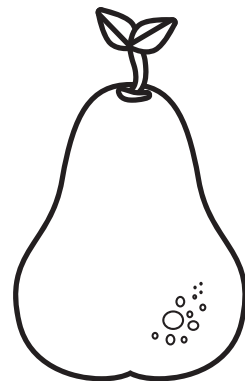
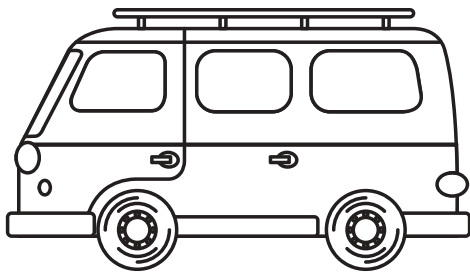

THE LETTER W

Trace the letter W

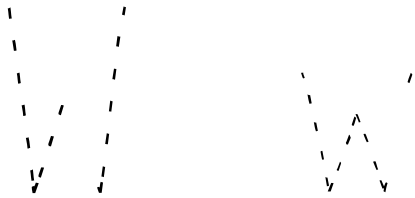

Write an upper and lower case letter W:

Colour all the items that begin with the letter W:

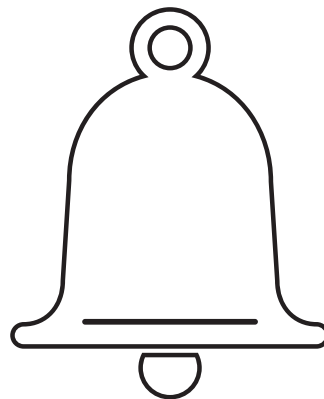
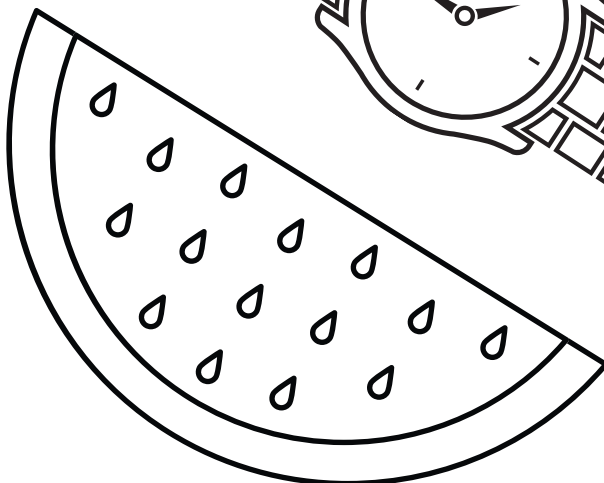
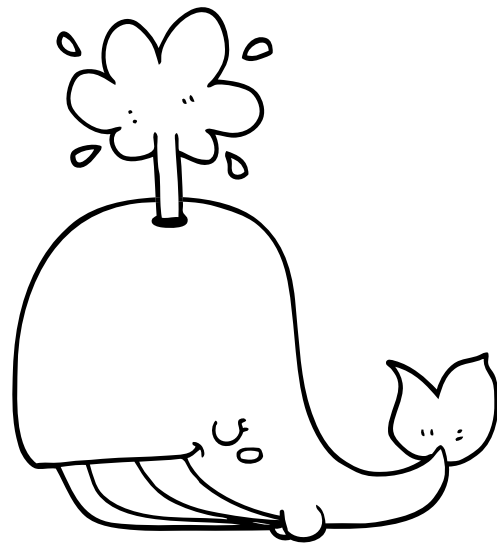
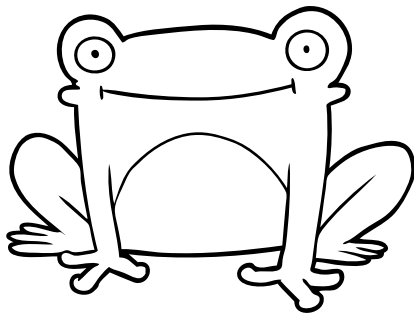

THE LETTER X

Trace the letter X



Write an upper and lower case letter X:

Colour all the items that begin with the letter X:

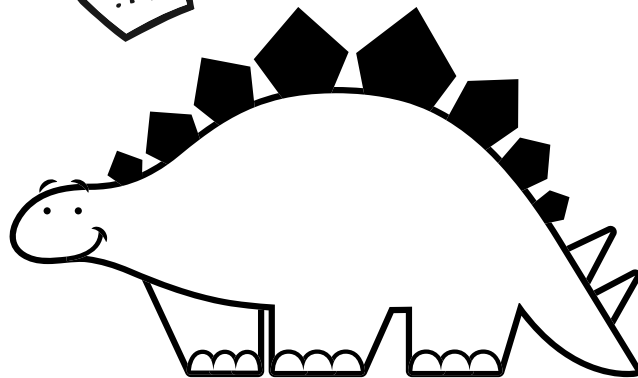
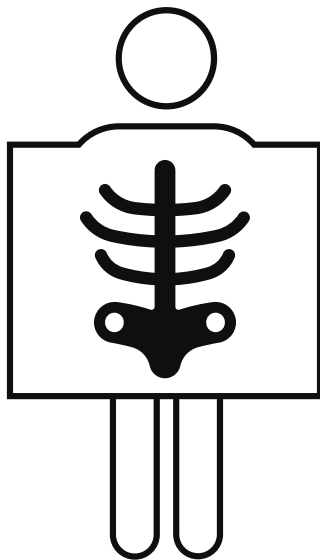
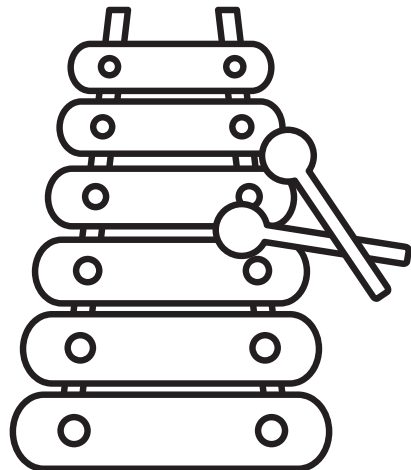
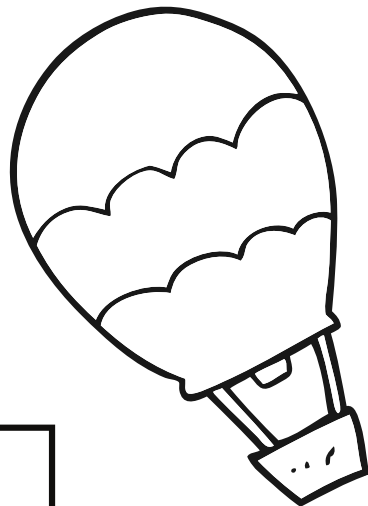
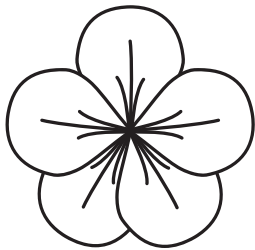

THE LETTER Y

Trace the letter Y

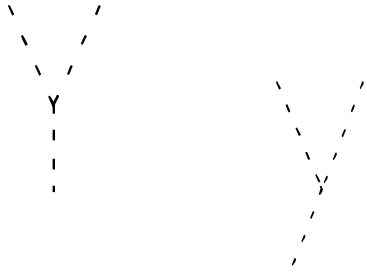

Write an upper and lower case letter Y:

Colour all the items that begin with the letter Y:

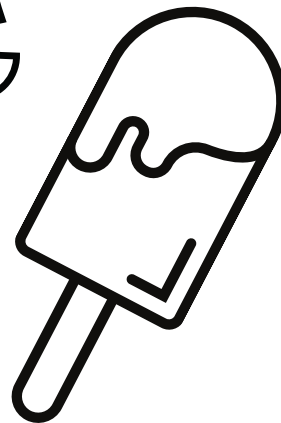
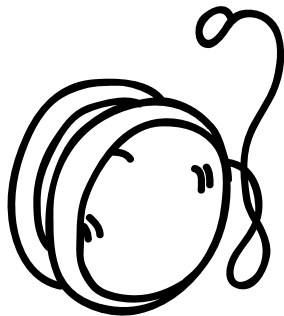
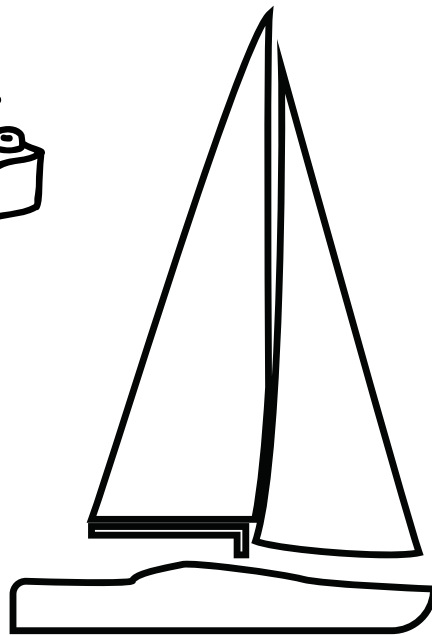
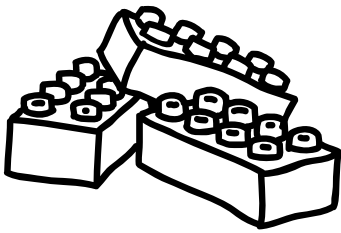

THE LETTER Z

Trace the letter Z

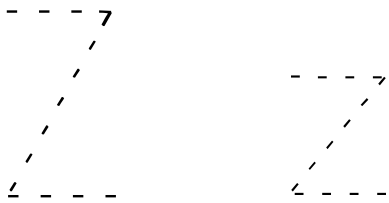

Write an upper and lower case letter Z:

Colour all the items that begin with the letter Z:

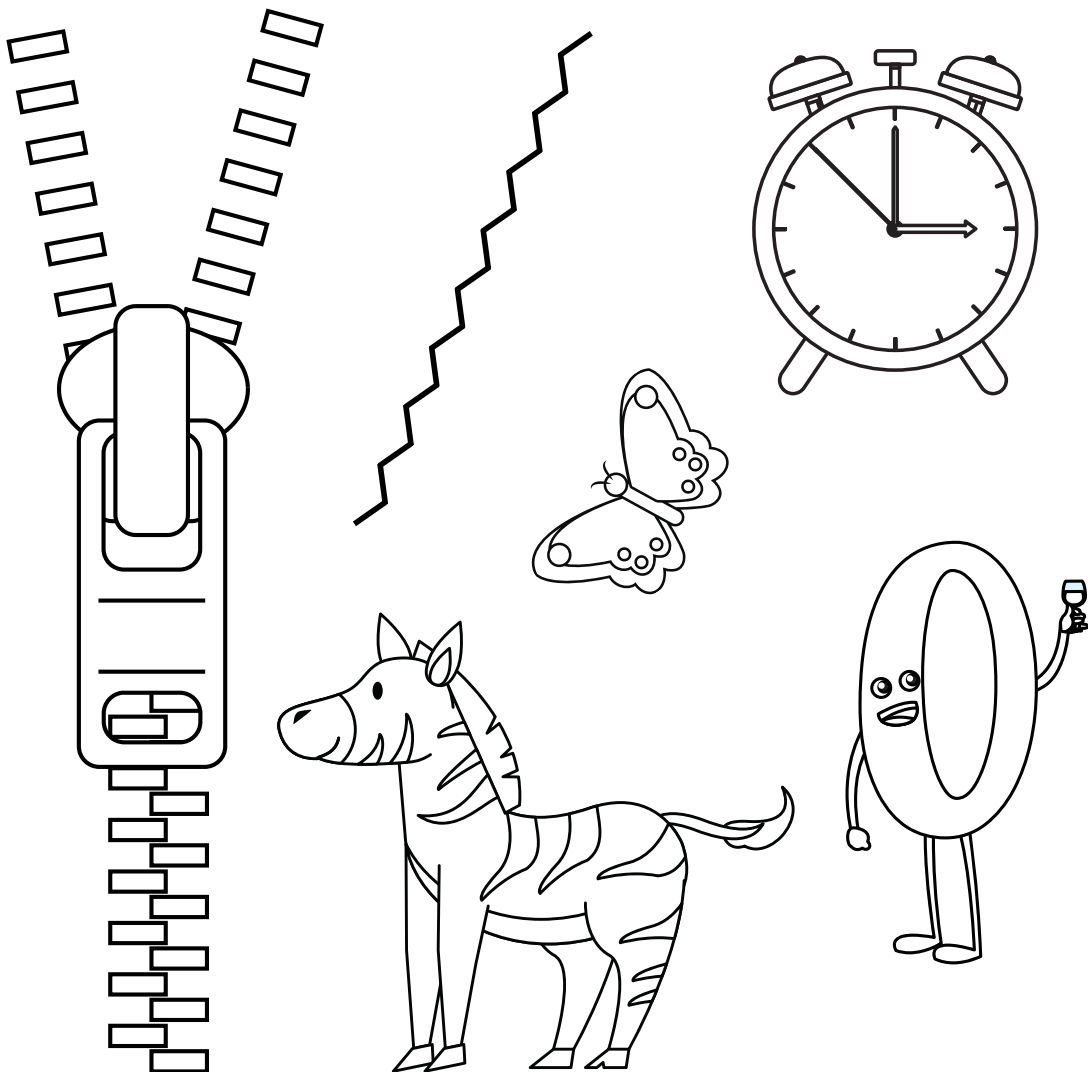

@Worksheetcreator

For more Free worksheets visit
www.spokenenglishtips.com